



From the Series of Articles on Lens

Names:

Tessar

by

H. H. Nasse

Tessar – Creation and Development of One of the Most Successful Camera Lenses of all Times

Like many other brand-named products, camera lenses also have their own names. The simplest method is for the respective manufacturer to use a protected designation for all of its lenses. Additional product families are often distinguished through a special name or suffix. Suffixes in the form of long listings of abbreviations have become fashionable to refer to the use of prestigious technologies such as aspheric lens elements or special types of glass.

the path of a single ray of light through a single lens surface. During this time, the search for usable solutions with which the aberrations of the lens elements could be sufficiently reduced was accordingly difficult. Intuition, experience and extensive knowledge of the general lens interactions were in demand even more than today to design and optimize good lenses. This makes it much more understandable that the successful result to what was often years of work required a name.

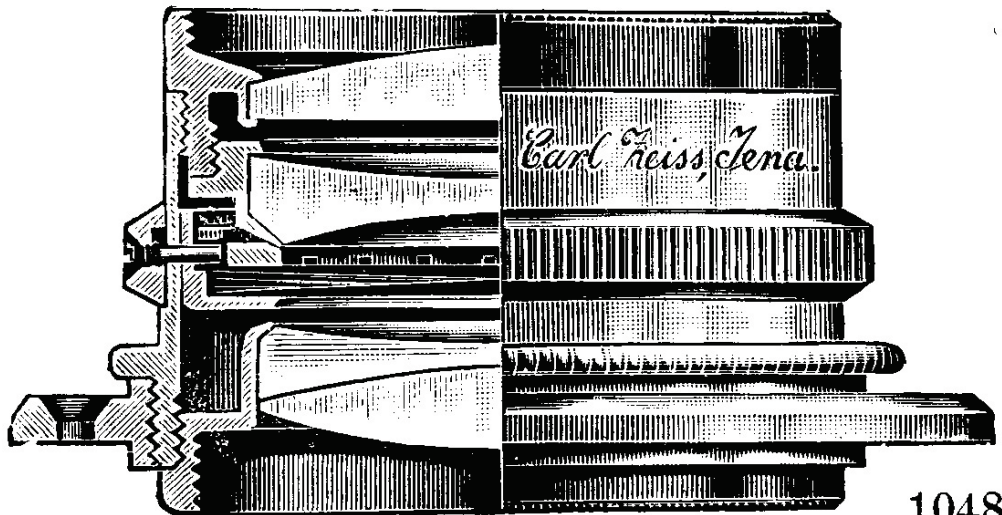

Cross section of the lens elements from the Anastigmat 1:9 and from the first ZEISS Tessar 1:6.3 based on the Unar design.

In the European optical industry and at Carl Zeiss, in particular, this has always been understated. On the other hand, lenses with different design principles were given special names: **Tessar**, **Planar**, **Sonnar**, **Biogon** and **Distagon** are examples of famous ZEISS lens names. In a new series of articles, we will identify the origins of these names and introduce the special properties of these lenses.

Almost all of these lens names come from a time when optical calculations were done without the help of computers. While we can now calculate several thousand surfaces each second with ray tracing, back then it took two minutes to calculate

The word Tessar is an acronym derived from the Greek word *tessares* meaning four. It expresses that this lens is comprised of four lens elements. Correspondingly, the patent from 1902 stresses the following properties:

*"A spherical, chromatic and astigmatic corrected lens comprised of **four lens elements** divided into two groups by the diaphragm. One of these groups consists of two elements separated by air, the other of two cemented elements. The refractive power of the surfaces separated by air is negative, that of the cemented surface positive."*

Protar and Unar: father and mother of the Tessar

You can often find articles explaining that this optical design is the improvement of the Cooke Triplets from Dennis Taylor – a three-element lens with a negative element in the middle – in which one of the exterior positive elements has been replaced by a cemented group to create the Tessar. There is, of course, some relationship between the two designs – this is due simply to the fact that usable solutions to lens correction problems are similar. Nonetheless, the inventor of the Tessar, **Paul Rudolph**, took an entirely different approach. He had calculated two predecessors, the **Protar** and the **Unar**, which were completely different from the Triplet. The Tessar contained parts of these two lenses, just like a child has genes from its mother and father.

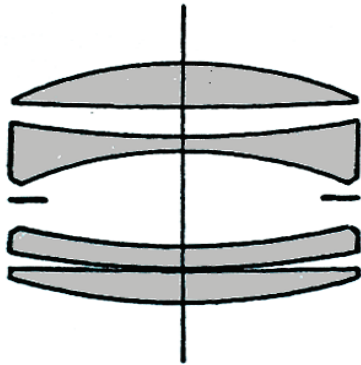

Another predecessor of the Tessar is the ZEISS Unar shown here, from which the two-element front element was used.

The predecessors to the Tessar were based on the key glass innovations of the 1880s. At the age of 26, physics professor **Ernst Abbe** joined the microscope workshop of Carl Zeiss in 1866 with the goal of establishing a scientific basis for the construction of microscopes. A key corollary of his fundamental work was that new types of glass were required to make microscope lenses even more powerful. He found a partner in chemist **Otto Schott** who found a solution to this task in the short period from 1880 to 1886. It quickly became obvious that these new Schott glasses were not only useful in microscopy, but also ideal for improving camera lenses. This potential, and economic considerations such as how Carl Zeiss could become more crisis-proof through diversification, led Carl Zeiss to manufacture camera lenses beginning in 1890.

All camera lenses built before 1890 exhibited considerable deficiencies in image quality, particularly when they were not extremely slow. Although spherical aberrations, chromatic aberrations and distortion were corrected relatively well on the new symmetrical lenses available from the 1860s (**Aplanat** from Steinheil and the **Rapid Rectilinear** from Dallmeyer in England), field curvature and astigmatism were so large that a lens focused to infinity in the center of the image frame delivered crisp images at the edge of an image of objects less than one meter away. This had to be taken into consideration while composing the image to ensure that the photos would not be entirely unusable. For example, interior scenes always had to be photographed from a corner of the room.

In the beginning it was the Anastigmat

The first camera lenses from Carl Zeiss were called **Anastigmat** and described how the company was able to considerably reduce the above-described problem. It was derived from the Greek word *stigma*, meaning point. Astigmatism is the aberration that does not generate point-shaped focus. The word anastigmat is therefore a double negative, a “non-non-point” lens. The first and simplest anastigmats were comprised of four lens elements, arranged in two cemented groups.

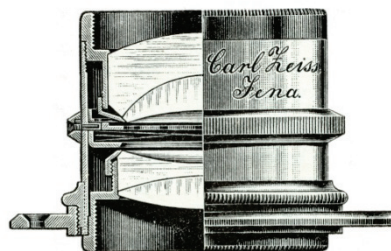

Fig. 8.

**Anastigmat 1 : 9 $f = 230$ mm
Serie III^a No. 5.**

(In $\frac{3}{4}$ natürlicher Grösse.)

One of the predecessors of the Tessar, a ZEISS anastigmat from the 1890s.

The front element is an old achromat, i.e. an achromat - a color-corrected pair of lens elements - made of the old types of glass. The old types of glass were crown glass with a low refractive index and relatively minor dispersion (color dispersion) and flint glass with a higher refractive index and higher dispersion. Flint glass, by the way, got its name from the use of flint as a supplier of the base material for glass: silicon dioxide. Furthermore, it also contained lead oxide which improved its viscosity when melted, making it easier for glassblowers to work with. At the same time, its refractive index increased, giving glass dishes more shine.

As a result of the combination of refractive index and dispersion, manufacturers had to apply to the cemented surface of the achromats the curvature seen in the sectional drawing to achieve the desired chromatic correction. With this surface curvature, it was possible to master spherical aberrations, but not astigmatism.

This was different with the new achromats made from the new types of glass melted by Otto Schott. These new types of glass were known as dense crown glass because they combined a relatively high refractive index with lower color dispersion. The combinations of refractive index and dispersion now available enabled a cemented surface in achromats with a collective effect, which could be used to correct astigmatism. However, with the new achromats, very little could be done to influence the spherical aberrations. Therefore, it was a logical idea to combine both types of achromats with complementing properties to create a lens in which an old achromat was used for the front element and a new achromat for the rear element.

Later, front and rear groups consisted of up to four cemented lens elements. The name Anastigmat finally became a generic term for all lenses corrected with the new methods and was no longer exclusively the domain of Carl Zeiss. These lenses therefore went by the name **Protar** from 1900 on. They represented considerable progress for the time, but compared to the lenses from the 1960s used for similar recording formats, they still exhibited significant aberrations.

In 1899, Paul Rudolph found that the effect of the cemented surface in the anastigmats could also be achieved using suitable spacing between stand-alone lens elements. This led to the **Unar** consisting of four single, non-cemented lens elements. The further analysis of these two systems led Paul Rudolph to conclude that a mixture of the two would demonstrate the best behavior. This resulted in the birth of the **Tessar**, which was comprised of the front element of the **Unar** and the rear element of a simple **Protar**, and featured lens speed of 1:6.3 (f/6.3). At a time when apertures of 1:8 and 1:20 were common, this was a downright "high-speed" lens.

Furthermore, his correction was quite good for the times despite rather moderate glass material efforts. This was important back then because anti-reflective coatings had not yet been invented, meaning that all systems featuring multiple lens elements and glass-to-air surfaces were automatically doomed to failure due to lack of contrast resulting from stray light. The maximum aperture of the Tessar soon increased to 1:4.5 and 1:3.5 as a result of the new calculations from **Ernst Wandersleb**.

Tessar design principle model for many manufacturers around the globe

The ingeniously simple design and the good performance in every aspect of lenses with moderate maximum aperture and with medium image angles made the Tessar one of the most successful camera lenses ever. During the term of the patent, Carl Zeiss issued many licenses to other manufacturers, and when patent protection ended in 1920, the design principle was used by a wide range of manufacturers around the world. It was the standard lens on many cameras well into the 1970s. During this period, it was also continuously improved without changing the general design. Simply the advances in glass technology, similar to the time of its birth, enabled performance increases which also demonstrate the potential of the basic idea.

From the outside, a Tessar from 1920 looks exactly the same as one from 1965, but the image quality of the newer lens is considerably better.

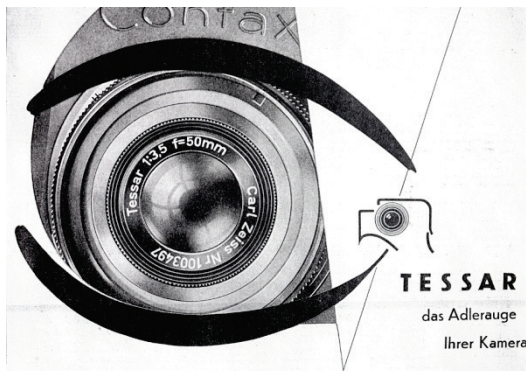

Nothing expresses the famous reputation of the Tessar better than the comparison with an eagle eye.

The Tessar brand name was and still is modified with prefixes:

Apo-Tessars were made of special types of glass to achieve better chromatic correction, which is required, for example, for the reproduction of line masters. **Pro-Tessars** were not intended for professional photography as could be suspected based on today's popular wording. They were complex attachment systems and customers were able to replace the front lens element of the Tessar on such cameras with the attachment system to change the focal length and transform the normal lens into a wide-angle or tele lens. From today's perspective, these convertible lenses were

a technical dead end because the focal length variations were modest, yet still required rather large and heavy attachments with a low maximum aperture. The reason for this rather unfavorable solution was that the mass-produced central shutter was preferred for too long. Most cameras today with interchangeable optics have a high-performance focal plane shutter.

The **Tele-Tessar** is a true tele lens comprised of a positive front group and a negative rear element, i.e. a system whose length is clearly shorter than the focal length, which makes long focal lengths more convenient. There is no similarity to the general design of the Tessar and is simply intended to utilize the popularity of the name. The **Tele-Apotessar** incorporated special types of glass for outstandingly good correction of chromatic aberrations.

The **Vario-Tessar** also has little in common with the general design of its namesake. Its name expresses that this Vario (zoom) lens delivers good performance at a moderate price – like the famous Tessar.

With the **Tele-Tessar T* 4/85 ZM** it is even more difficult. It is in no way a tele lens with a reduced mechanical length like the earlier Tele-Tessars, but a nearly symmetrical lens and therefore practically distortion-free. If you are looking for famous ancestors with the same lens cross section, you will find the Heliar from Voigtländer – but Carl Zeiss does not have any property rights to this name. And because the latter is also similar to the Tessar, the name is still somehow justified. This example demonstrates that the rules of lens names have their limits and exceptions because there are always mixtures and overlapping between the traditional designs.

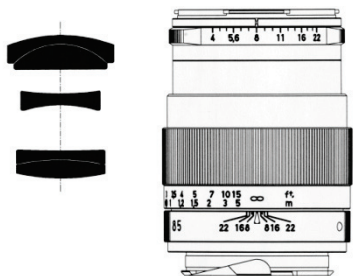

Modern example of the Tessar design, the Tele Tessar 4/85 ZM for the 35 mm format.

The name Tessar lives on in our state-of-the-art **miniature lenses** for camera modules in the mobile phones of our partner Nokia. The similarity to the classic Tessar is that four lens elements are usually used. The small size is also a related feature and an absolute must for the small volume of a pocket-sized device. However, the functionality of this tiny lens no longer has anything to do with the original Tessar patent. It is usually

designed with four lens elements with aspheric surfaces. The resolution of these small and economical optics is far superior to the best 35 mm lenses – but this is due to the short focal length and the small image field.

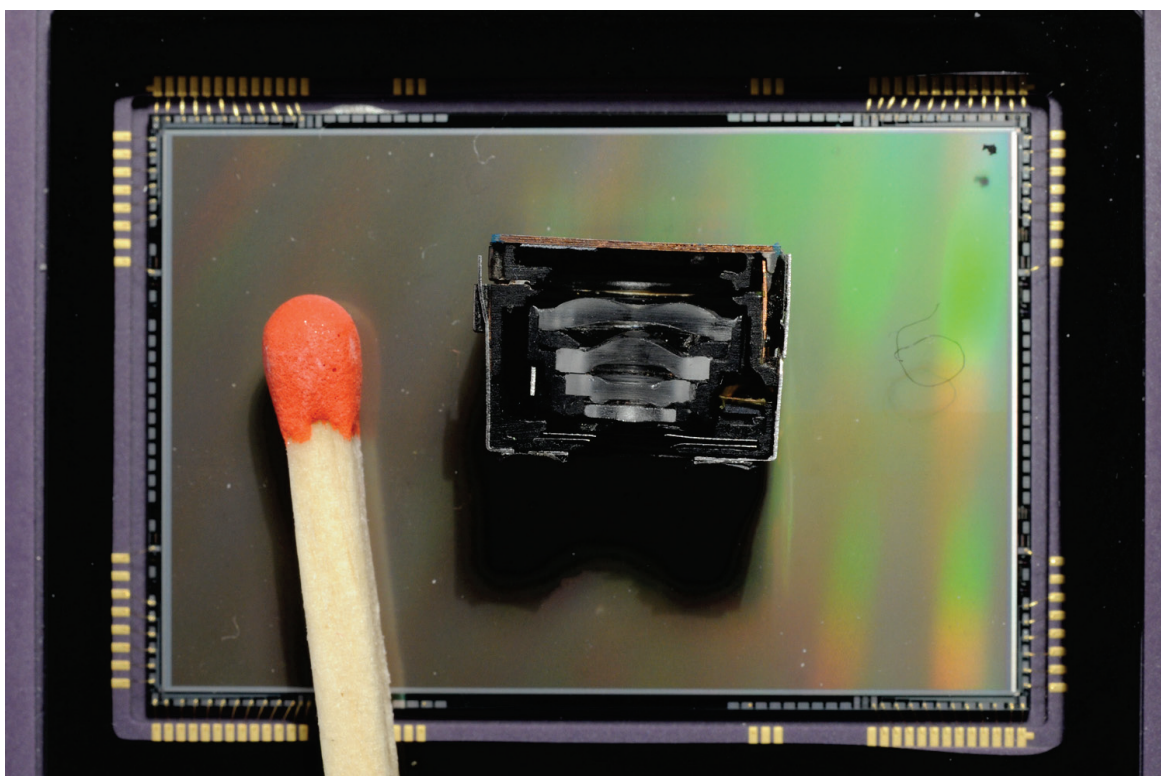

Cross section of a four-element lens for the camera module in a mobile phone. The head of a match is provided to demonstrate how small it is on a 24x36 mm image sensor. You can clearly see the strong aspheric surfaces of the lens elements.

Some performance data shows the improvement of optic:

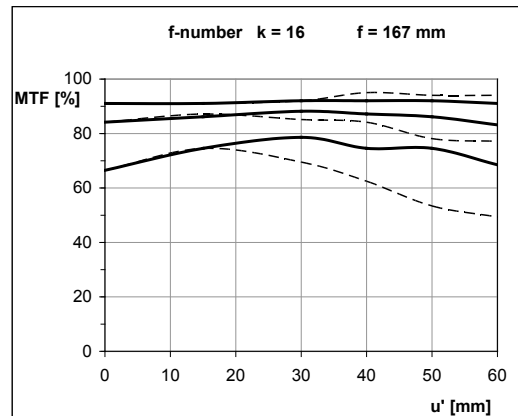
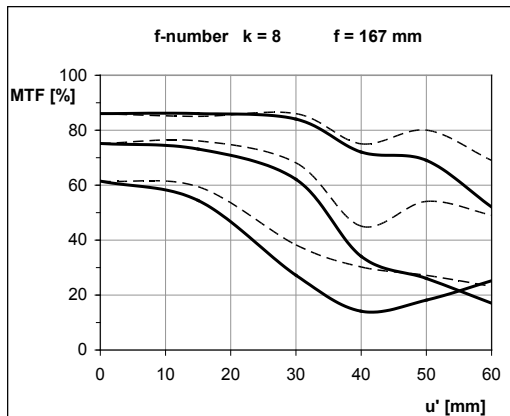

Performance data (modulation transmission) of a historical Zeiss anastigmat from 1897. At first glance, the curves look like those of modern lenses – but the measurement was made at much lower spatial frequencies of 4, 8 and 16 line pairs per mm. If you remember that this lens was intended for the 13x18 plate format, it is understandable why so many pictures from the time were so razor sharp. A lens for the 35 mm format then had to have the same curves for 20, 40 and 80 Lp/mm. In optics, as with a car – size plays a role.

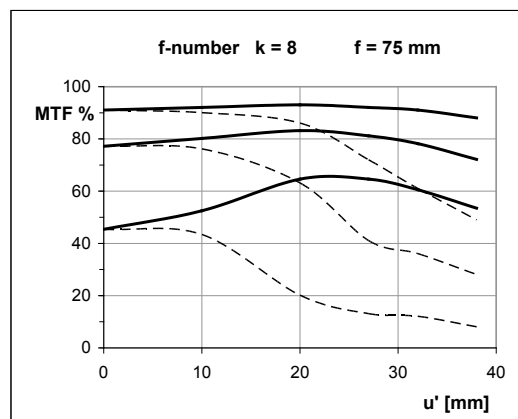
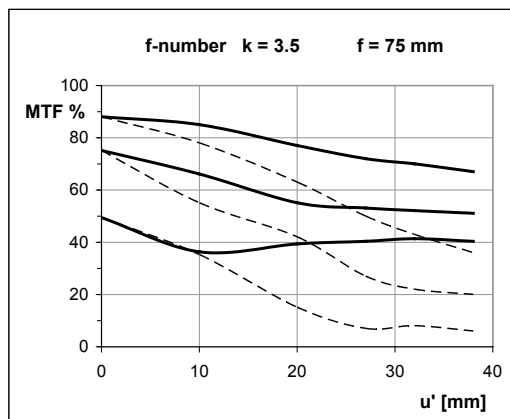

Performance data (modulation transmission for 10, 20 und 40 Lp/mm) of a Tessar 3.5/75 for 6x6 roll film cameras from 1922.

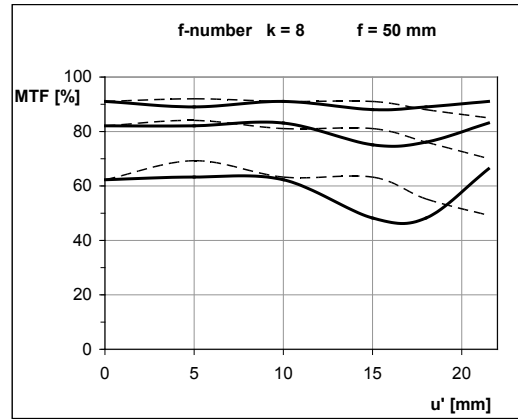
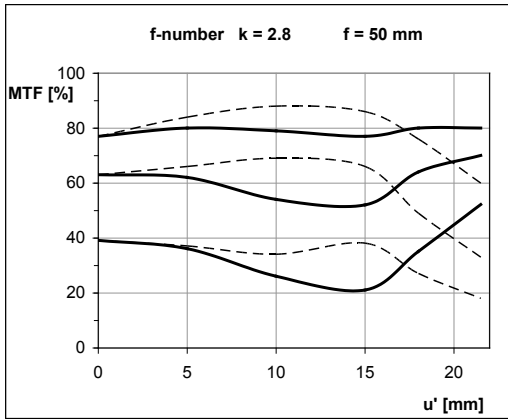

Performance data (modulation transmission for 10, 20 und 40 Lp/mm) of a Tessar 2.8/50 for 35 mm SLR cameras from 1962.

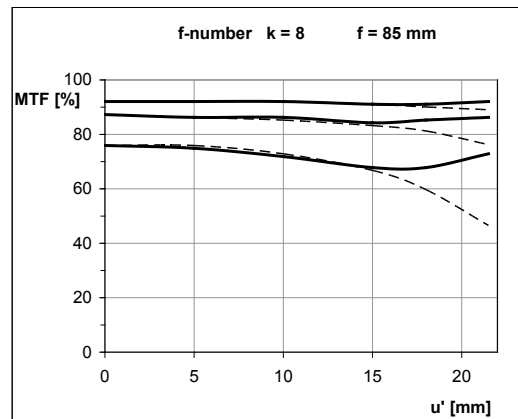
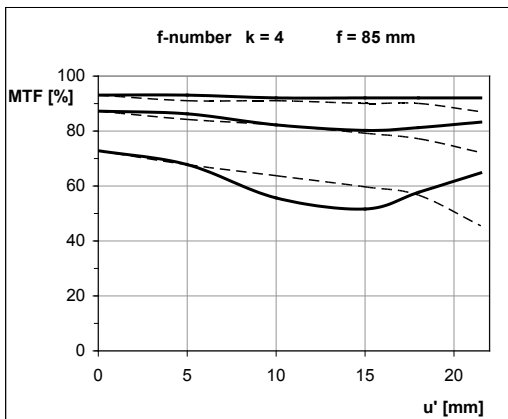

Performance data (modulation transmission for 10, 20 und 40 Lp/mm) of a modern Tessar design, Tele Tessar 4/85 ZM for 35 mm rangefinder cameras. It features even crispness into the image edges that are virtually independent of the aperture and is practically distortion-free.

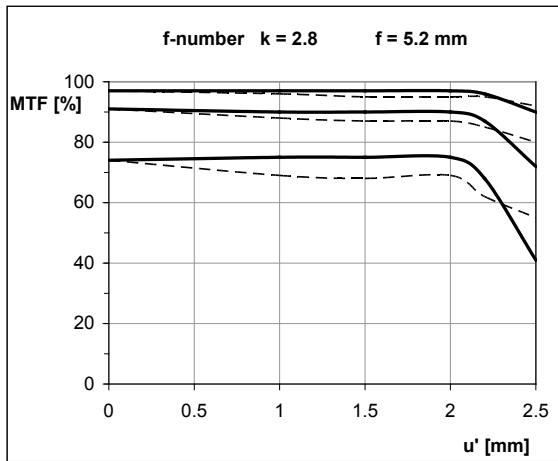

Performance data of a Tessar lens for a mobile phone camera measures with 20, 40 and 80 Lp/mm. It is better than the best 35 mm lenses – but only for a very small image.



Anastigmat (left front), Unar (back middle) and Tessar lenses for different camera formats.